



urban SCAFFOLDING LTD.

12112 – 156 Street
Edmonton, AB T5V 1E6
Mailing
Box 9076 Stn WECSC T5P 4K1

Telephone (780) 452-5950
Fax (780) 452 2476

Hi! I understand that you are interested in learning more about scaffolding. Well, we here at Urban Scaffolding have made up this little book that we hope will help you. . .

It's called

Be Your Own Scaffolding Expert

We have many new products in this brochure.
And we think it's informative and interesting.

Come on inside and see



FIRST OF ALL

There are only two basic parts
To an Urban Frame Scaffold

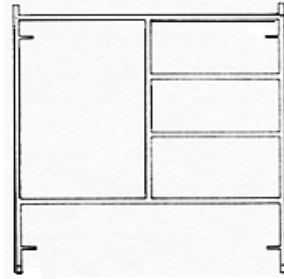

An end frame

and

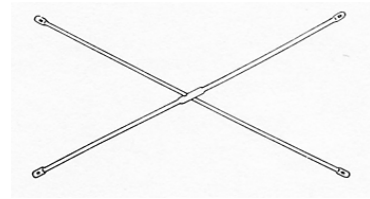

a cross brace

TWO END FRAMES, TWO CROSS BRACES PLUS FOUR COUPLING PINS (They are always in the frames – unless you request them to be taken out.) EQUAL

A BASIC SECTION
OF SCAFFOLD

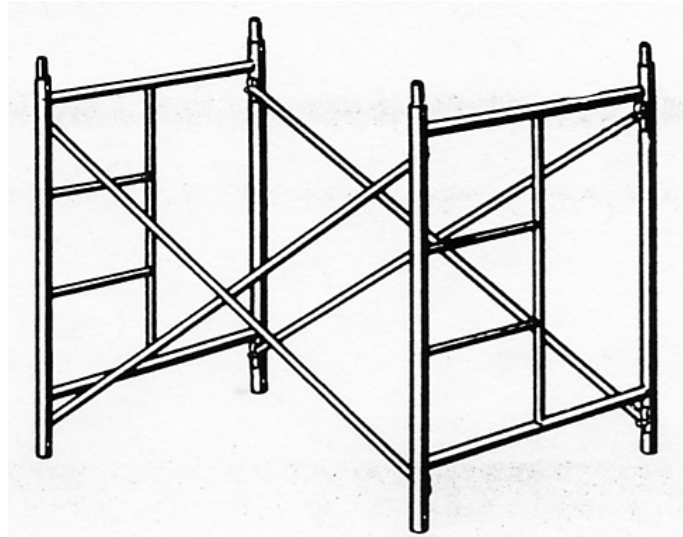

The basic sections are expandable

U
P
As in towers

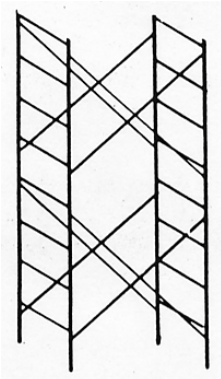

Or OUT
as in runs

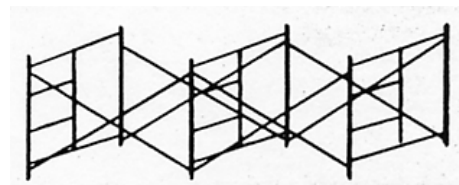

Or
BOTH
like this

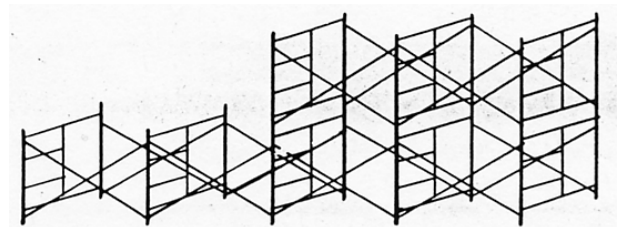

When ordering scaffolding always refer to basic frame & cross brace only, not sections, runs, lifts or other terms.

The braces are held on Urban Scaffolds with our Quicklocks.



We think the quick lock is pretty special because it is very fast to lock and unlock and has no loose parts to lose or drop . . .

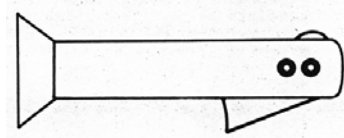

The Quicklock can hold on just one brace as necessary in the tower scaffolds . . .

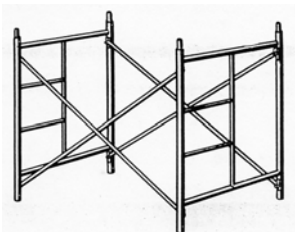

. . . or to hold two braces as needed in runs of scaffold

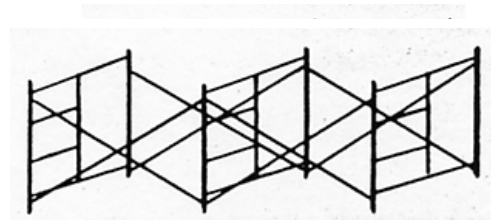

To stack on frame on top of another the coupling pin holds the frames in place and aligns the legs.

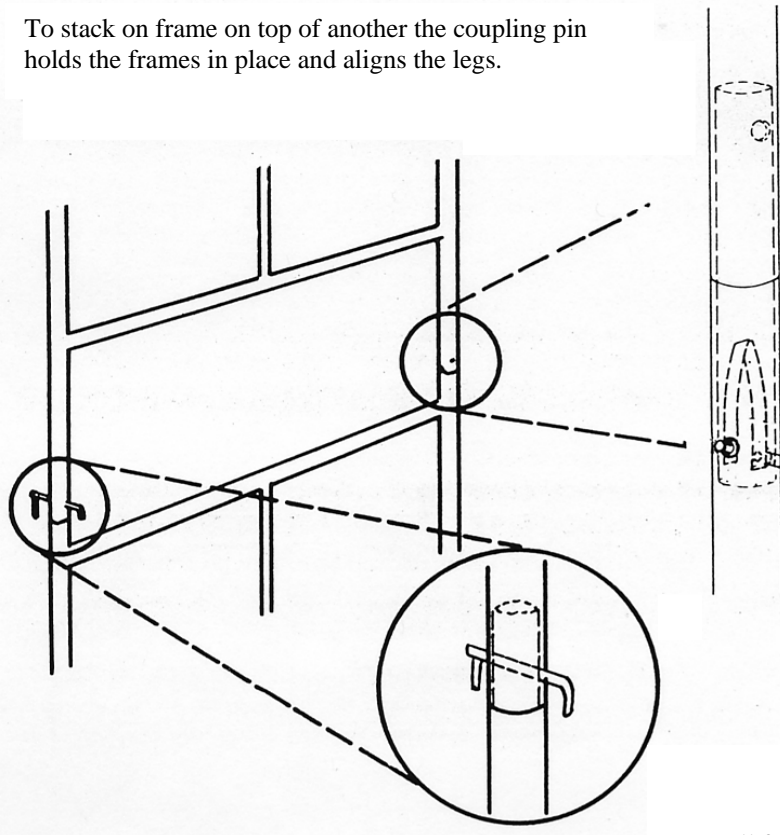

The Urban built-in coupling has enough play to let the frames be put on top of one another one leg at a time . . . and again, there are no loose parts to handle.

Spring retainers hold the coupling pin to the frames.

All frame scaffolds should be locked together with toggle pins for safety.

Urban Frames come in all different shapes and sizes

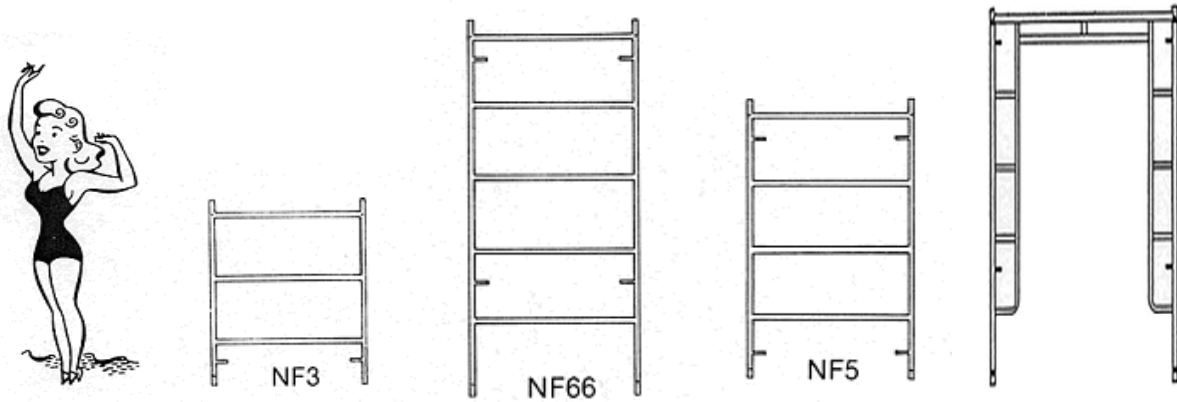

The first 3 are called ladder frames and the last one is a narrow walk through frame. They are about 36" wide. The ladder frames come in 3', 5', and 6'6" heights.

They also come in standard (or 5' widths) and again in 3', 5' and 6'6" heights as below.

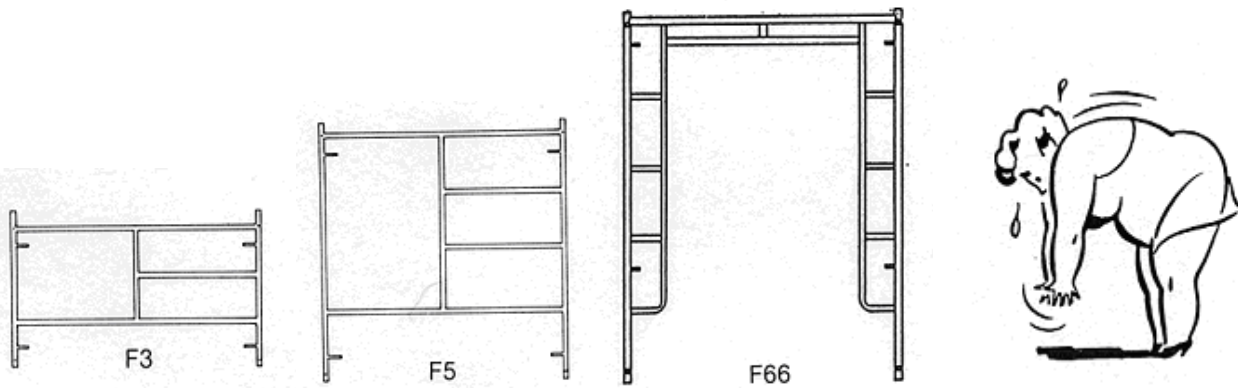

Urban also has some speciality frames like these

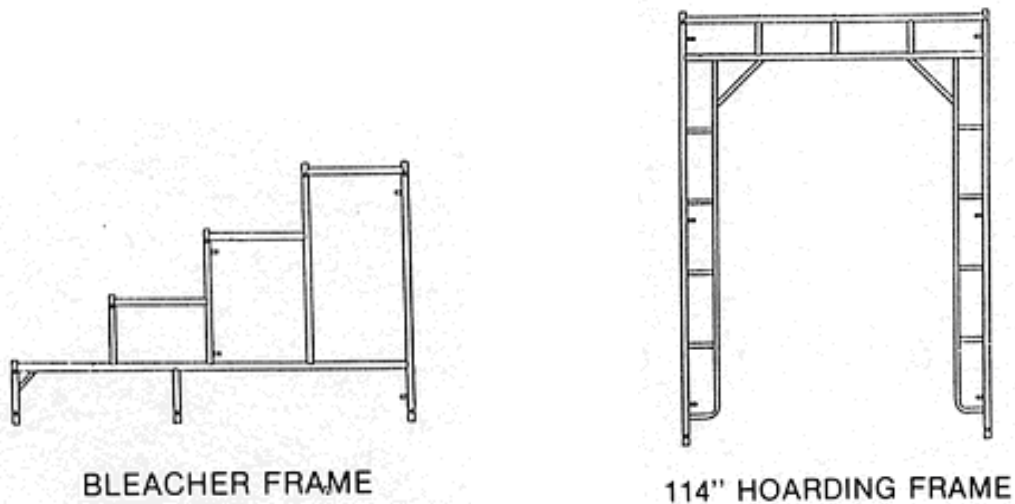

Cross braces also come in different sizes to fit different frames

to allow various spacing between the frames

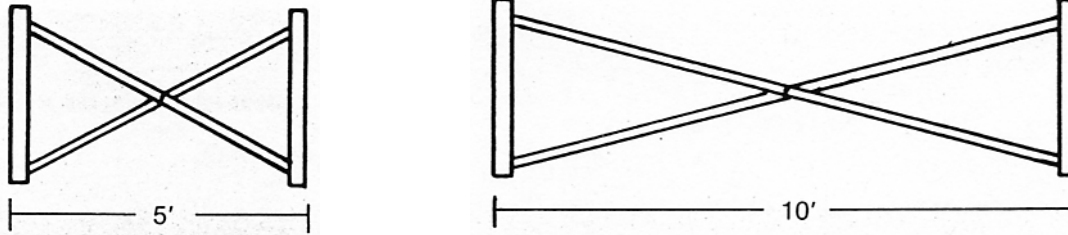

The size of the braces used will depend on the length of the customers planks, the weight the scaffold must support, area to be covered, etc.

FOR SPECIAL USES WE MAKE A STRADDLE BRACE (as shown)

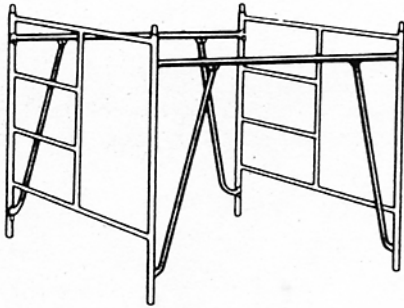

It's used for straddling

- Furniture
- Machinery
- Materials
- Or allow people to walk under

Here is a chart that tells you which braces are used with the various frames to give you the spacing you want or need. There are more combinations but these are by far the most often used.

FRAME	SPACING OF FRAMES				
	3'	5'	7'	10'	Straddle brace
NF3	B32	B52	B72	B102	for
NF5	B34	B54	B74	B104	7' & 10
NF66	B34	B54	B74	B104	spacing
F3	B32	B52	B72	B102	only
F5	B34	B54	B74	B104	STB7
F66	B34	B54	B74	B104	STB10

By using simple charts like this one you can easily figure your requirements for most jobs. Plain old common sense is more valuable than a slide rule.



Utility Scaffolds

Here is a special section of scaffold called a Utility Scaffold: details are on the next page. It is handy for any light duty jobs for painters, drywallers, electricians, etc. It is also very useful for the handyman or handywoman to do jobs like painting ceilings, changing light bulbs, repair plaster cracks and on and on . . .

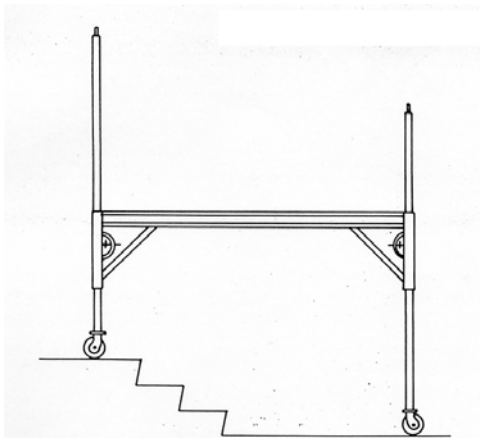
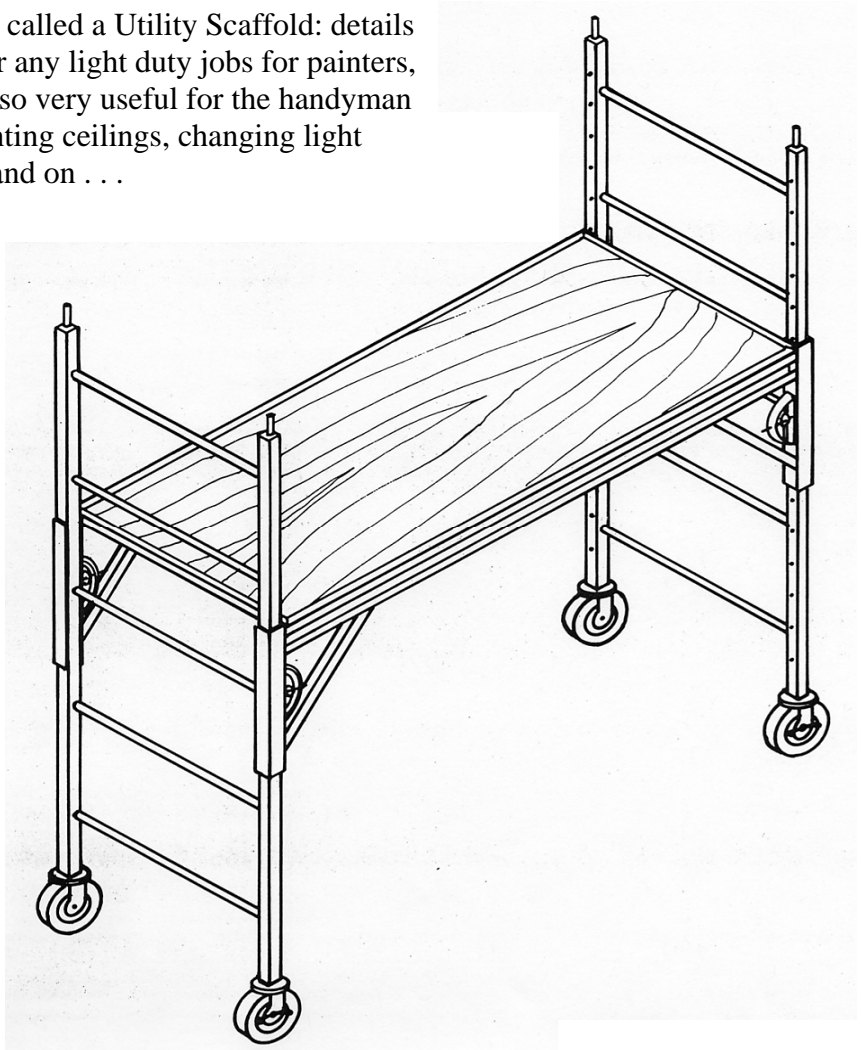

One of the many uses for the utility scaffold is how they work on the stairs.

Utility Scaffold Components

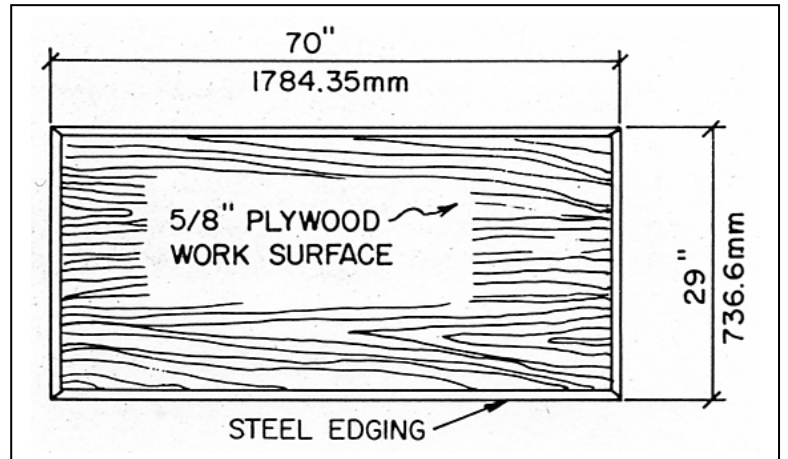
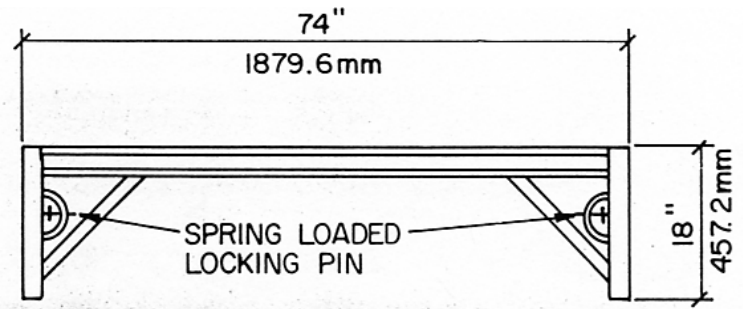
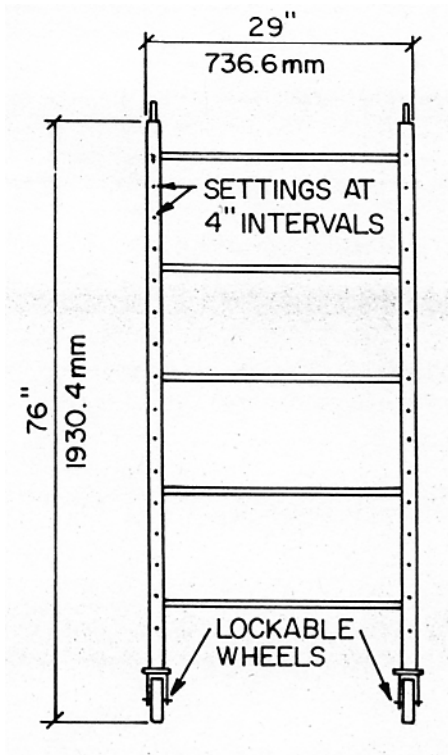

Extra Components for the Utility Scaffold

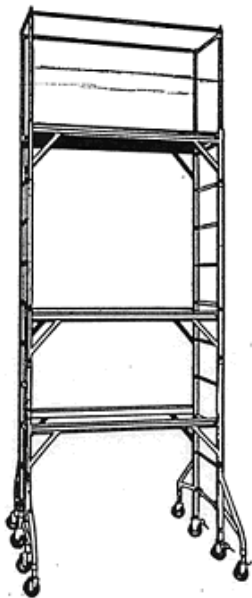

Adding Utility guardrails when working at heights over 10' in height. (Check your local regulations and site rules for Height restrictions.)

Adding extra platforms when working at different levels.

Adding outriggers when the height to base ratio is exceeded and tie-ins are not possible.

All fixed (non-movable) scaffolds should be set on **BASE PLATES**

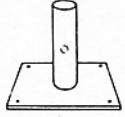

BP

A fixed base plate that is stationary



Screwjack Base Plate

Adjustable base that adds 2" to 25" to scaffold height. Comes in 24" & 36"



Screwjack U-Head

Adjustable screw with U-Head for holding wood or Alum Beams.



Screwjack Caster holder

Adjustable screw adds 8" to 25" to scaffold height. It is used with base plate or castor.

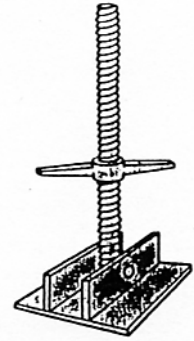

Swivel Base Screwjack

For sloped based areas like roof tops, tank bottoms or hill sides.

Sills or Mudsills should be used under all supported stationary scaffolds.

These brackets are used as a hanging bracket.

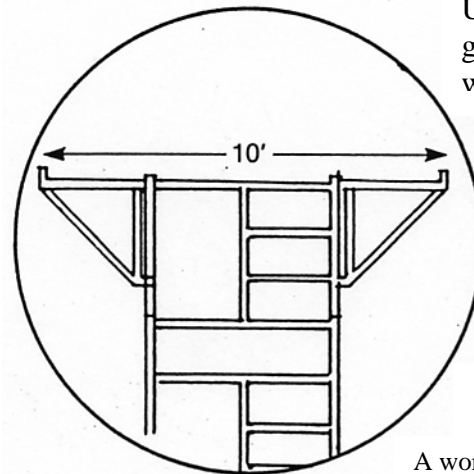
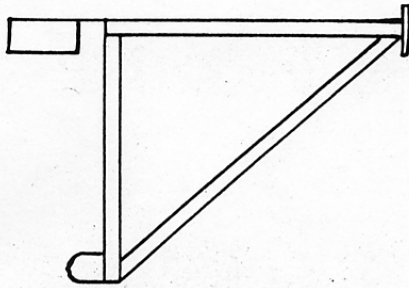

Used this way really gives the worker a wide platform.

For making the working platform wider or using different working levels we use a hanging bracket.

A word of caution: this application can cause tipping. There should be no materials stored on brackets unless restrained from tipping.

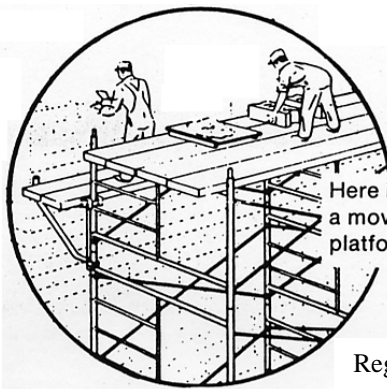

Here it is used as a movable work platform by masons

Regulations require guardrails on this scaffold.

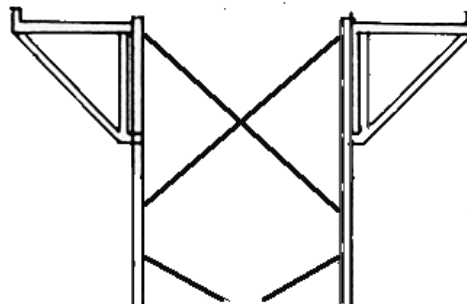

At Urban, we use outriggers as end brackets use. A 5' deck works in between them.

Guardrail System

Most provinces require a guardrail on scaffolds 10' (3m) or higher. Some jurisdictions require stricter regulations.

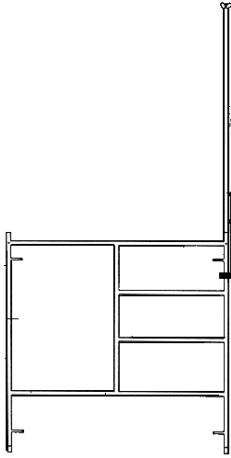

This is a guardrail post. We have 2 styles. This style has the extra support arm. The other style doesn't have the extra support arm used on hanging brackets and end brackets.

The guardrail post fits on all four corners of a tower. In the case of a scaffold run, the guardrail posts sit on all the scaffold legs. The guardrails come in many different sizes to allow for various spacing on different jobs.



Tube and clamp can be used where guardrails cannot reach.

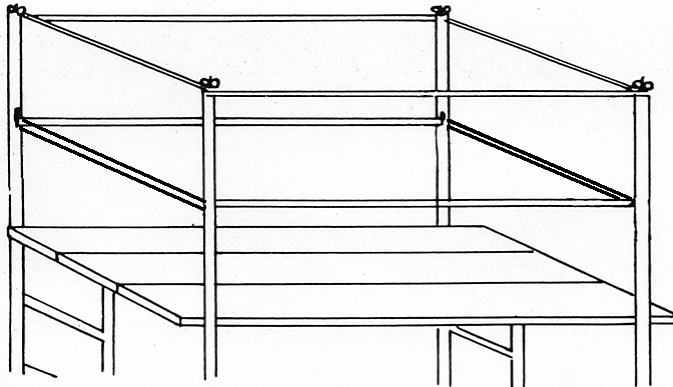

The top and lower side rails are held with quick locks.

Access Gates are also part of the guardrail.



Toeboards

Some regulations require toeboards (kickplates) on scaffolds when there are people below the platform. At Urban Scaffolding our toeboards are a minimum 140mm (6") in height. Best to check your local regulations on requirements.

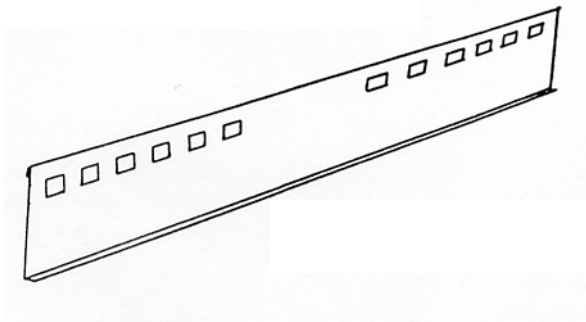

Metal Toeboard with hook

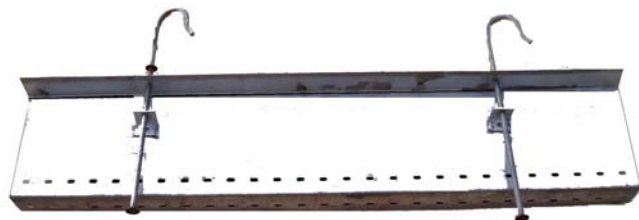

Decking & Planking

Planking is essential when using scaffolding. At Urban we have 2" X 10" nominal size (actual 1 1/2" X 9 1/2") laminated scaffold planks. These laminated planks come in 6', 8', 10', 12', and 16' lengths.

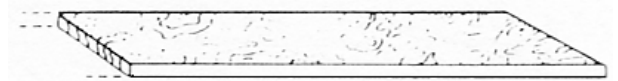

We also have 19" wide decks with hooks that have aluminium (for lightness) side rails and cross members (underneath the platform) and the hooks. The platform is plywood. These decks come in 3', 4', 5', 7', and 10' lengths.

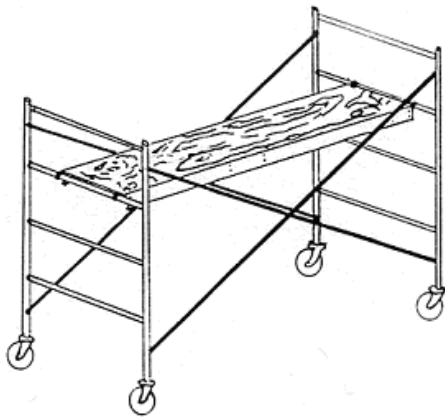

New
Urban now has **half decks** for
platforms that cannot fit a full deck.



Steel planks

Urban carries 4' and 7' steel planks for sites that do not allow wood products. They are also used for heavy-duty platforms.

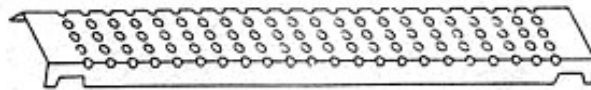

Steel grating

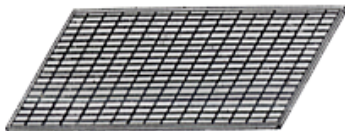

Steel Grating
comes in 2'x4'
and 16"x4' sizes



Up to 10' high (3m) equipment is usually passed up by hand up to the top. Above 10' a hoist standard is useful in raising material to the top of the scaffold. At the right you see a **Pulley arm and post** in use. It will carry up to 100lbs. The pulley arm and post fits on the top of any frame by slipping it over the coupling pin and clamping it to the leg. The head swivels so material may be easily swung over the scaffold platform.



Guardrails would be required on this scaffold

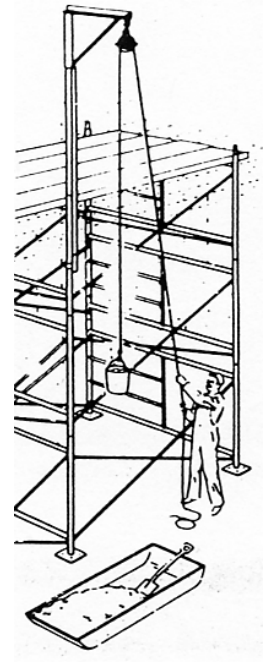

The pulley wheel you see is a PW-1. It holds rope up to 1" thick. The wheel turns very easily as it turns on roller bearings.

Rolling Towers

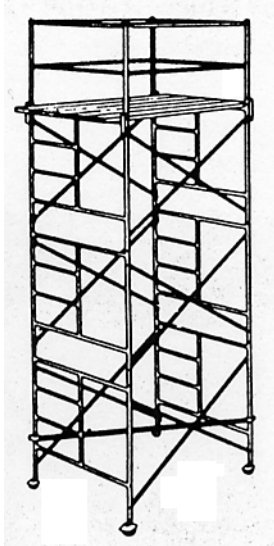

Rolling towers are very popular with the lighter trades such as painters, electricians, heating and ventilating workers, and maintenance people. Because they move easily around a room they save the expense of scaffolding a large area.

One very important rule to remember about rolling tower is: **THE SMALLEST BASE DIMENSION OF THE BASE OF THE TOWER SHOULD NOT BE LESS THAN 1/3 OF THE TOWER HEIGHT...**

This is the same for all scaffolds.

We rent and sell castors with 8" wheels. Our castors have a neoprene wheel with an aluminium center. All of the castors we handle have brakes so they can be locked to hold a rolling tower firmly in place. Castors should always be pinned to the leg so they don't hit something and fall out. Urban also stocks cast iron wheels with a hard rubber wheel for sale only

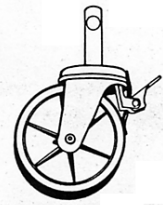

In light applications, castors can be used in combination with the screwjack castor holder. This combination allows for the adjustment of the tower for ceiling heights and slightly uneven surfaces.



Urban also has 16" pneumatic wheels available for rent. The screwjack is included with it. Because the 16" wheels have no brakes the wheels must be blocked from movement when a worker is on the scaffold.

Another important rule when constructing a rolling tower is **ALWAYS USE THE PLAN (Sway) BRACE**. You can see in the drawing how Urban's plan/sway brace fits on the section diagonally. This prevents the tower from racking or getting out of square.

The plan brace must be used on the bottom and every 15' vertically on the tower.

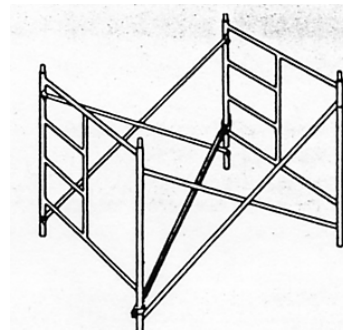

Outriggers are available to increase the base dimension of a scaffold. They clamp solidly on to the frame and allow the rolling tower or stationary scaffold tower to be built higher. Again you must consider the smallest base dimension and make sure it is not less than 1/3 of the tower height.

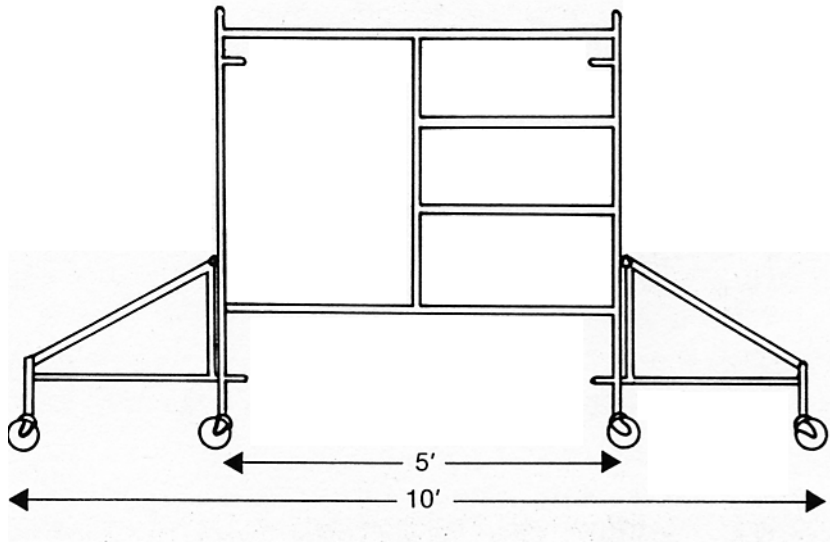

Here the rolling tower base was increased from 5' to 10' with the outriggers.

When the ground is too soft or rugged to use castors a pneumatic tired scaffold becomes an ideal answer to the problem.

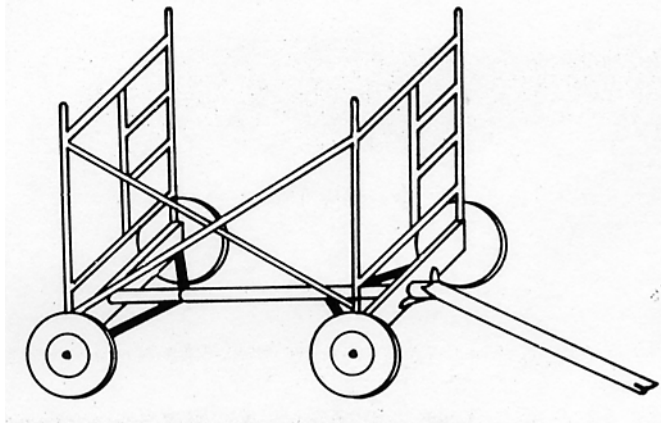

This wagon is shown with 2 - 5' frames.

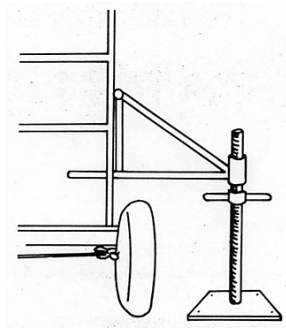

Outriggers can be adapted to scaffold wagons with the use of a Screwjack base plate.

All Urban Scaffold wagons come equipped with locking brakes (not shown). There is no need to block the wheel like the 16" wheels.

Last, but not least, remember that on rolling tower, all frames must be held together with bolts or toggle pins. These pins hold the tower as a solid unit and make it safe to use. Don't forget to lock the castors into the frames.



Well, you are about half way through our little book now. If you are tired, take time out and get a cold beer. We will wait for you right here.

Putlogs (sometimes called bridges or trestles)

Putlogs are a very important part of scaffolding. You should become very familiar with them and the many ways in which they can be used. There are two basic uses for putlogs, to save scaffolding and to bridge over objects such as driveways, machines, pews, and many others. Here are a few cases in which the putlogs are used.

1. Here the putlog is used to save scaffold. Instead of using for separate towers, two towers were installed and a putlog was used to bridge between them. Then, two other towers were erected using the putlogs as a base.
2. Here the putlog is being used as a cantilevered platform to reach an otherwise inaccessible place. Notice how the putlogs are always braced for safety.
3. The putlogs in this case are being used to tie the towers together at the bottom. This, of course, gives the tower greater rigidity and makes it a safe working platform.

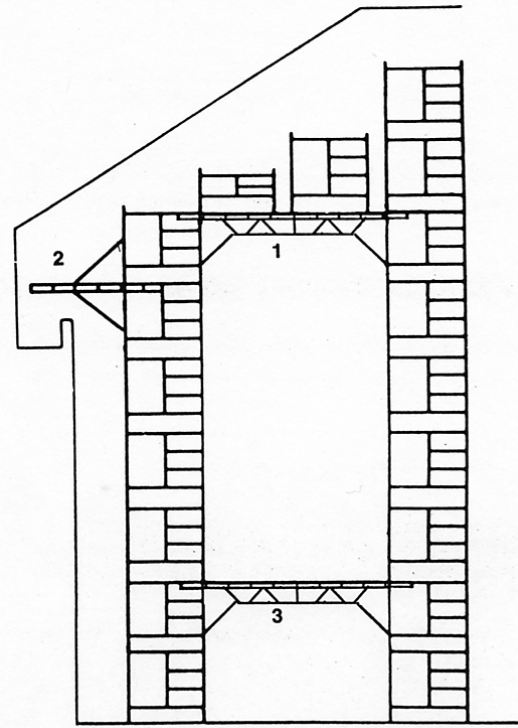

You can be sure that your customers will thank you for showing them how they can save money by using putlogs.

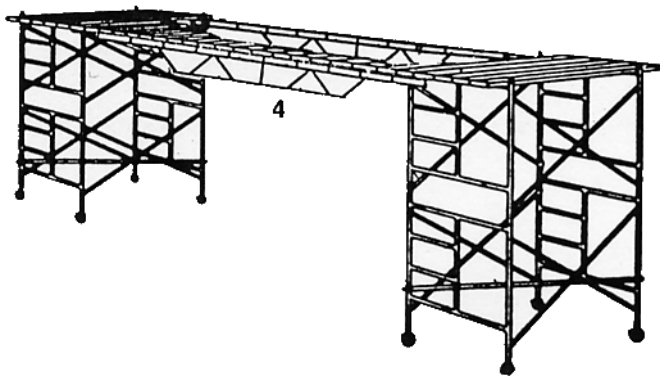

4. Here is another instance where the putlogs are used to save scaffold. You will notice that at the same time this rolling tower will bridge desks, pools or other equipment that might interfere with normal scaffolds.

The guardrails and knee bracing and cross braces were left off this drawing to better show how the putlogs are being used.

There are numerous ways to attach a putlog to the scaffold. One way is to use Putlog Hangers shown here. Another way is to use clamps.

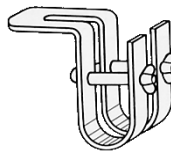

Caution: Putlog Scaffolds are considered light duty scaffolds. And remember a competent person should erect all scaffolds.

Stairways

Urban has two types of stairways. The first stairway is used with a 5' wide x 7' long frame scaffold. These stairs are designed for easy access and egress. Because the stairways are less than 2 ½' wide caution must be used when two people pass in opposite directions.

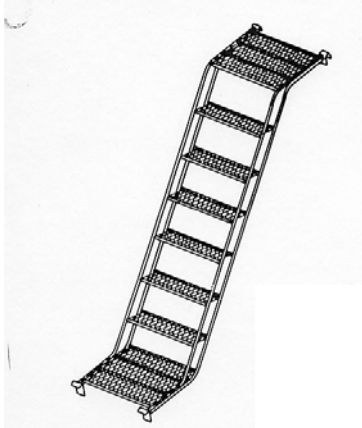

Single unit without handrails

Don't forget the auxiliary girt at the first level for the stairway to hook onto.

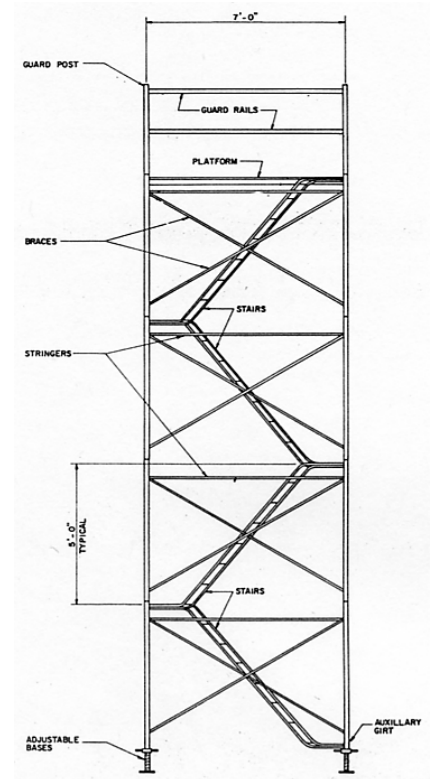
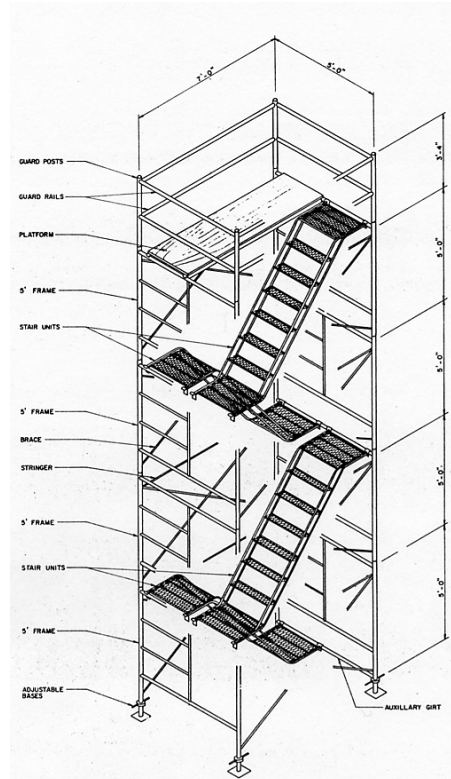

Handrails for stairways are not shown but are available as per safety regulations.

The second type of stairway works on a 6'6" height interval. The width and length of the scaffold are usually 7'. There are other illustrations that work with these stairs but the height must be at 6'6". The 6'6" stairways don't come in one piece like the 5' Stairway. One stairway is made up of 2 stair stringers, 2 handrails, 8 steps and toggle pins.



Picture of a 6'6" stairway on a System Scaffold

Ladders

For straight vertical access – Urban has 5’ and 3’ Ladders. A starter bracket is required at the bottom of each run. Materials and tools may not be carried up a ladder because the worker should have 3-point contact on the ladder at all times.

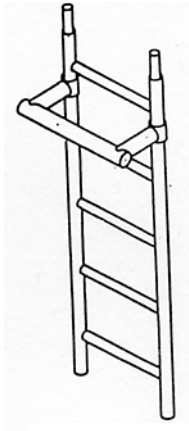

5’ Ladder

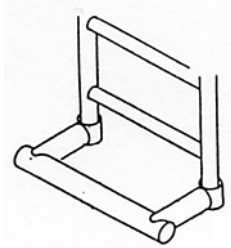

Starter Bracket

When ladders are used and go higher than 20’ there must always be a rest platform (landing) every 20’ (6.4m). One way of making a rest platform is shown here. Remember that ladders must extend at least 3’ (1m) past the platform.

Outside ladders need proper access. This can be achieved by using a swing gate.

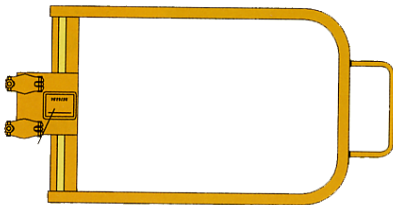

Urban also has a small stock of 40’ extension ladders for areas where just a ladder will do.

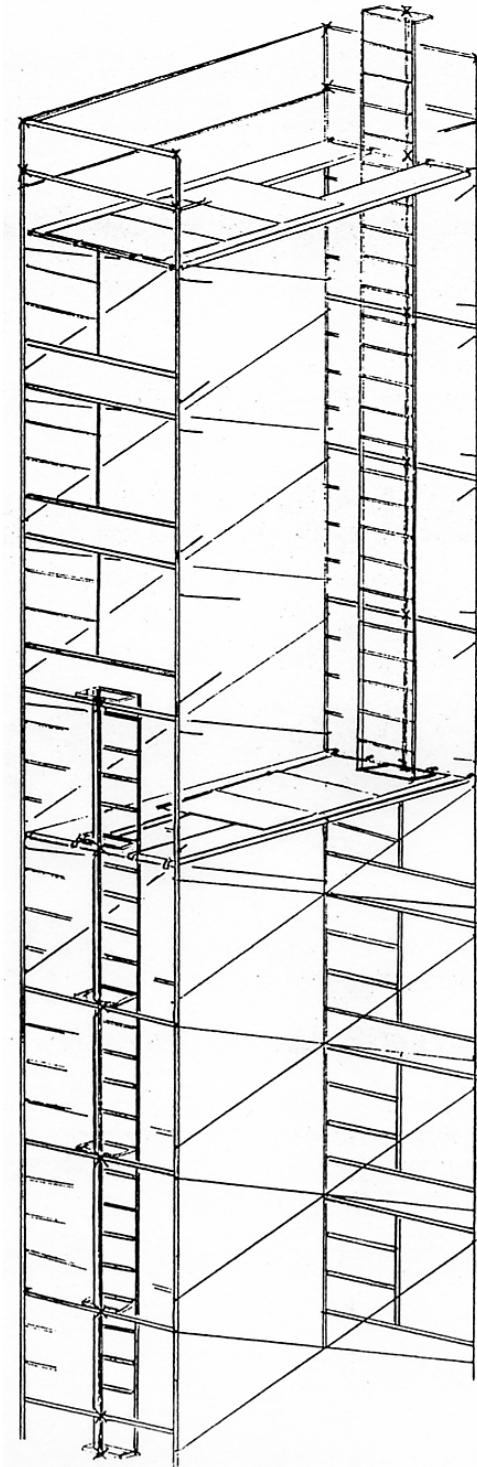

One of the most versatile and interesting items in the Urban line is. . .

Tubeloc

By using lengths of tubing and the two different fittings that are available you can construct a special scaffold for otherwise inaccessible places. Tube and clamps also make versatile bracing to strengthen and tie in towers.

Right Angle Clamp

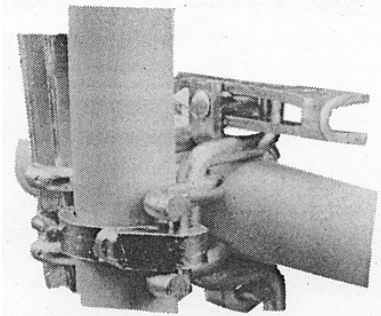

For joining vertical to horizontal tubing in any 90° application.



Swivel Clamp

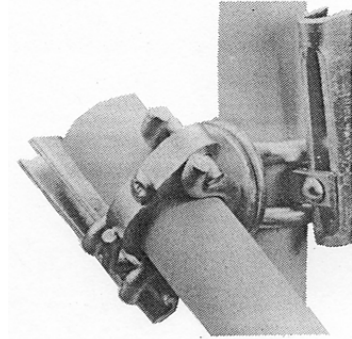

For connecting two tubes at any angle. Used mainly for bracing purposes. Should not be used to replace a right angle clamp.

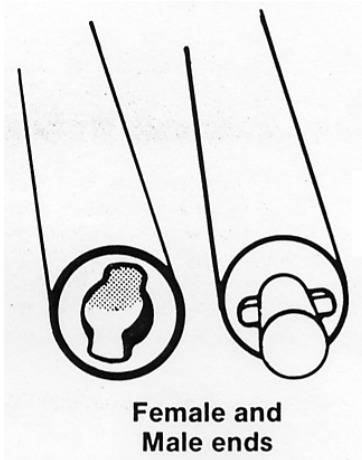

Female and Male ends

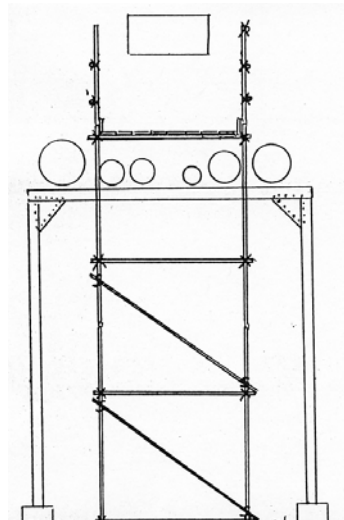

A special application over obstacles such as pipe racks

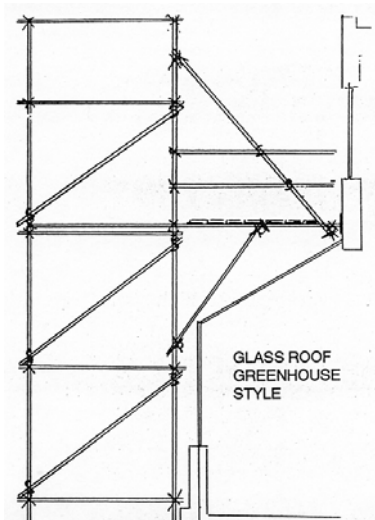

Or cantilevers to otherwise inaccessible work areas. . .

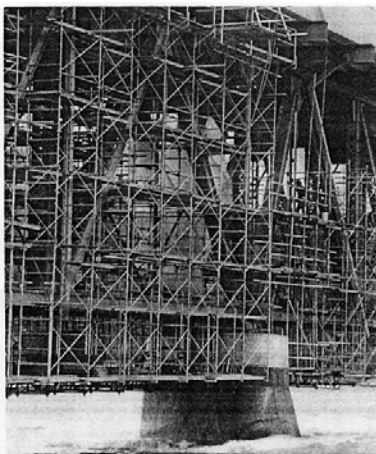

Or in combination with other scaffold (frames and putlogs) for big jobs

And even complicated applications like suspended-rolling cantilevers.

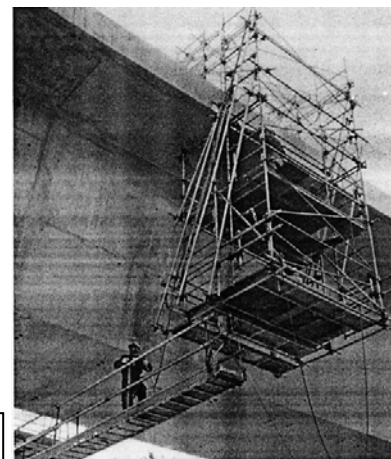

Remember
Tube & clamp scaffolds must be built by an experienced competent person and must be designed by a qualified person.

Introduction to Urban Single Pole Scaffolding
(a type of Tube and Clamp Scaffold)

First of all there are only four pieces that make up the Single Pole Scaffolding.

1. Aluminium Tubeloc – It comes in different lengths.
2½', 5', 8', 10', 12', 15', & 20'.
(Most other lengths can be made up with these sizes)
2. Bearing Bracket – The angle iron with a hook at one end and a clamp at the other end.
This is used to support the planking.
3. R/A Clamps - This holds 2 aluminium tubelocs at right angles (or the guard rail to the upright) and at the same time braces the scaffolding.
4. Wall Clips – The small but important little part must be fastened to the studs of the building (or equivalent – meaning concrete, brick, block, welded to steel, etc). It holds the bearing bracket at one end and keeps the scaffolding from falling either into or away from the wall.

Here is how you start: Measure from the top of the building down 6'6" and make a mark, from this mark, again measure 6'6" down and make mark, measure down 6'6" again and make another mark – Do this until you have a mark that you can reach from the ground. This is your starting point. Nail a wall clip at this level at the corner or at one side of the wall being set up with the scaffold. Now place a mudsill (2x8 or 2x6 at least ½" thick) on the ground, stand up a 10' aluminium tubeloc. Make sure the female end is put on the mudsill. Put a bearing bracket into the wall clip and attach the bearing bracket to the upright aluminium tubeloc. Take another 10' aluminium tubeloc, bearing bracket, and wall clip and repeat first step along the wall to a maximum distance of 10'. Using 2 R/A clamps, fasten one 10' tubeloc from one upright to the other upright under the bearing bracket. Place a plank on the bearing bracket at waist height on the building side (or on the inside) of the uprights. This is your basic set up!!!

Now go horizontally along the wall and install supports at a maximum of 10' intervals or less and vertically up the wall at 6'6" intervals.

Double guardrails are required after the 3M (10') height.

Remember

Single pole scaffolding is considered a light duty scaffold. There must be no storage of materials. If single pole is to be hoarded or tarped-in, consideration must be given to the wind effect, snow load, etc on the scaffold. Not recommended without an engineers approval.

Here are a few pictures of Urban Scaffolding SINGLE POLE SCAFFOLDING. It is very effective and economical for lathing, plastering, stucco, cedar siding, shingling faces of walls, etc.

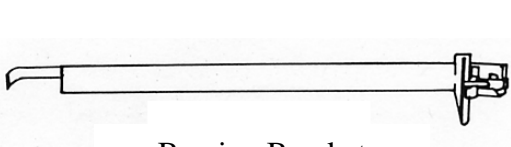

Bearing Bracket



Wall Clip

Tube w/ hook

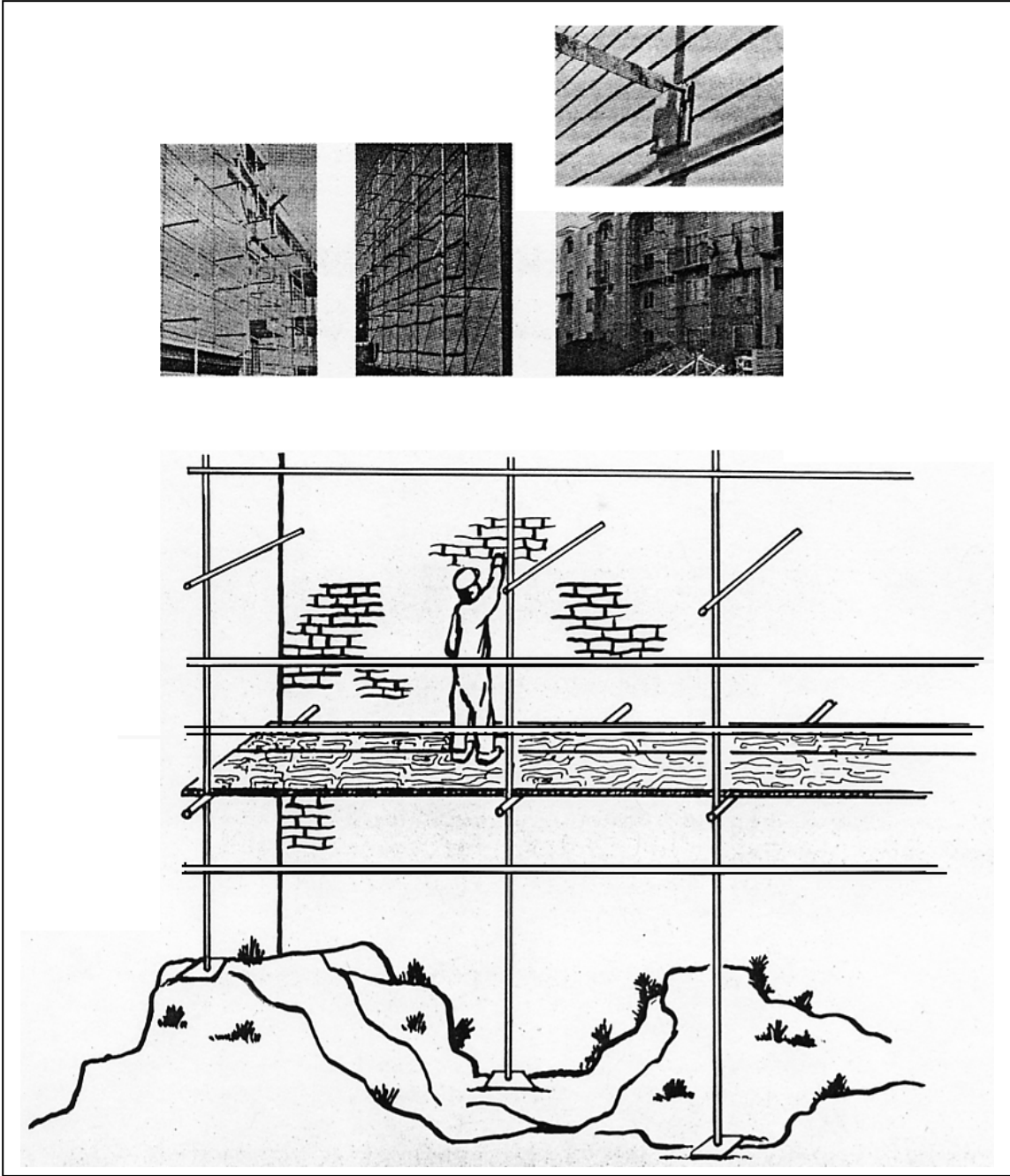

One of Urban's addition to the family of fine scaffold products is the system scaffold. System scaffolds are made up of the most basic components of Standards, Ledgers, Bay Braces and Base Collars. In addition to the basic components Urban carries the return ledgers, Bay Brace Couplers and the Rossette Ring Couplers. Check with your Urban specialist for the right size and the many uses of the System Scaffolds.

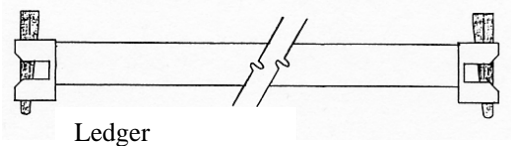

Ledger

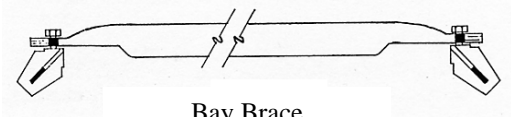

Bay Brace

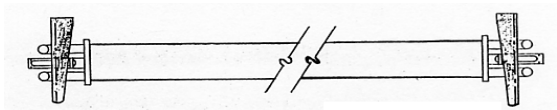

Return Ledger

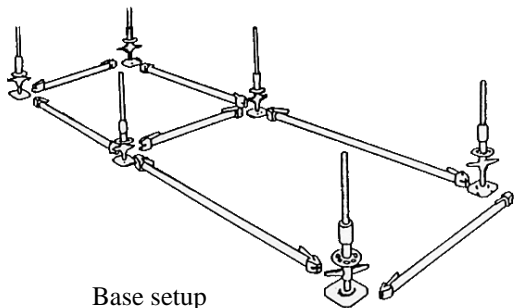

Base setup

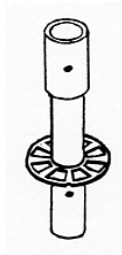

Base Collar

Rossette Brace Coupler



Rossette Ring Coupler

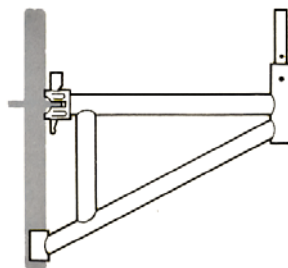

2' Side Brackets

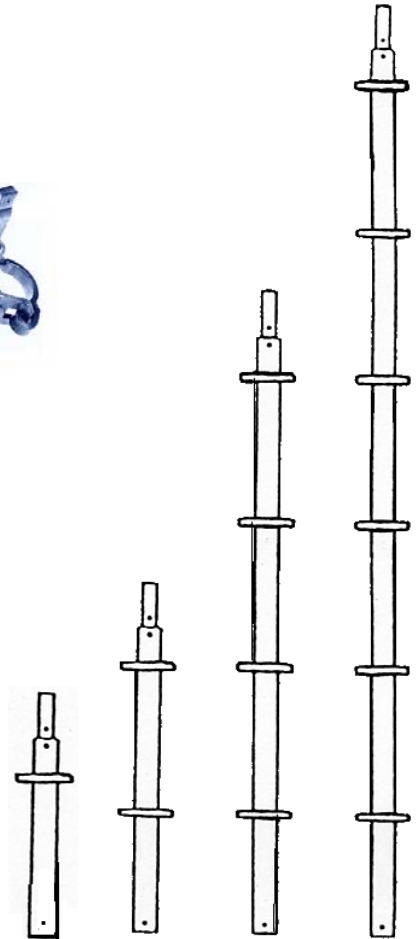

Standard (.5m, 1m, 2m & 3m)

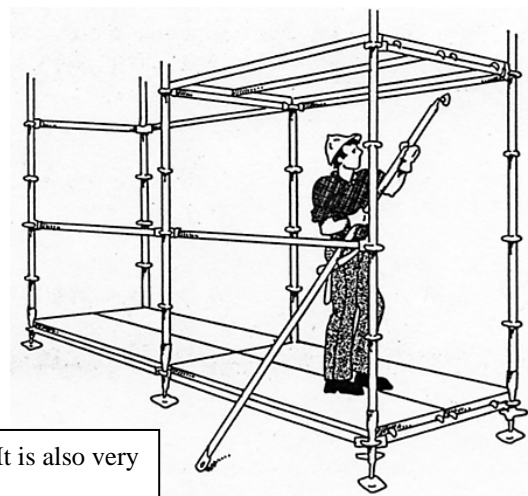
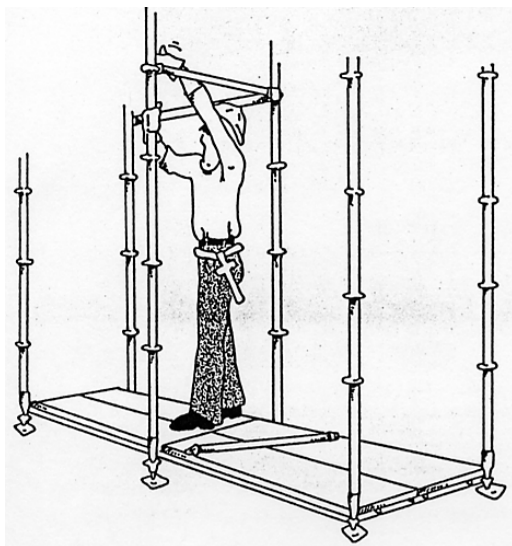

It is easy and quick to erect, even for one man. It is also very strong, solid and safe.

Construction Debris Chutes



We think the debris chute is pretty special because it is very fast to install and is lightweight, durable and inexpensive. Some applications are:

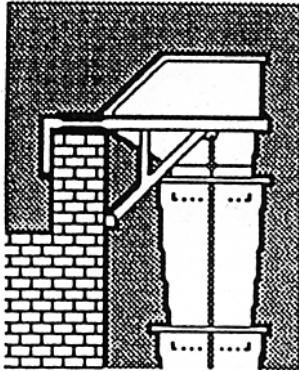

Top entry from window or parapet

OR

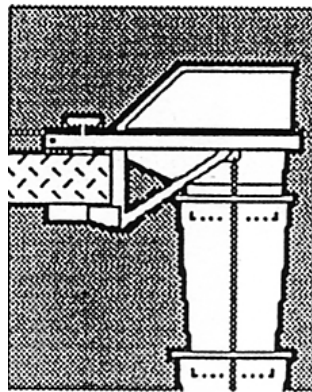

Top entry from a concrete slab

OR

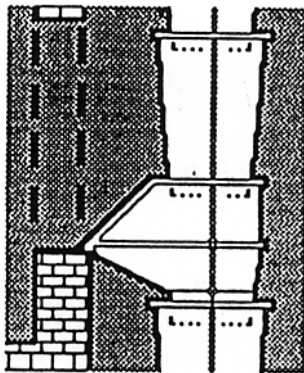

Intermediate Entry

EVEN

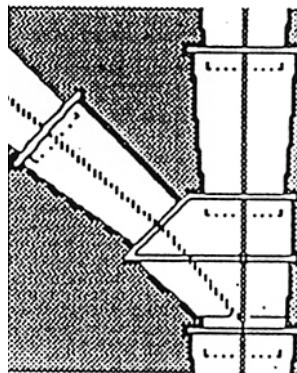

Merging

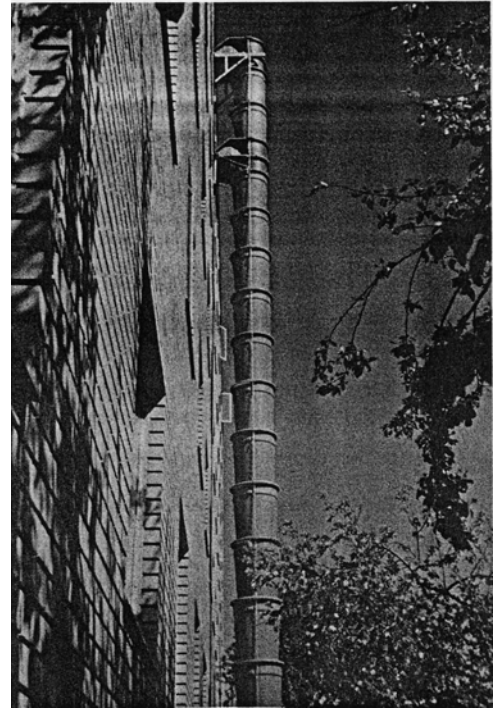

Royal Alex Nurses Residence

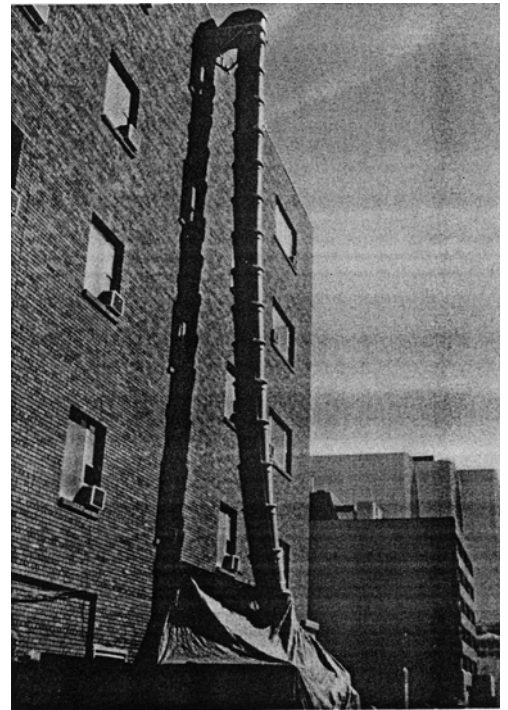

Mayfair Hotel

For more accessories



This way

Alum Beams

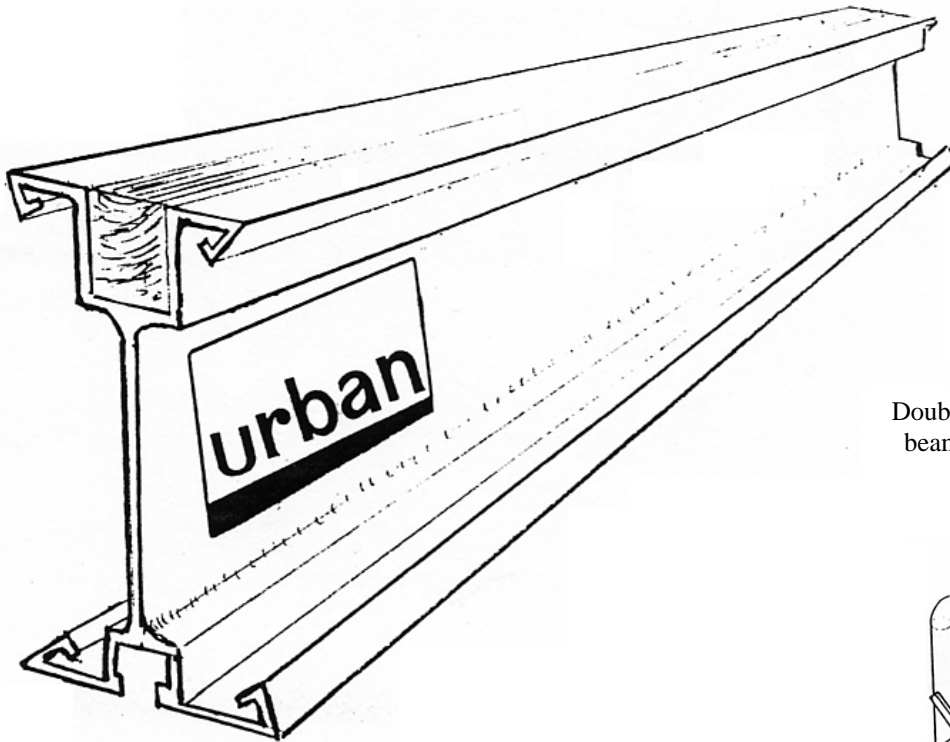

Alum beams come in lengths of 6', 8', 10', 12', 14', 16', 18', 20', 22', and 24'. The height of the beam is 6 1/2". They are used for shoring and light duty access platforms.



Double grips – are used to secure the beams at right angles to each other

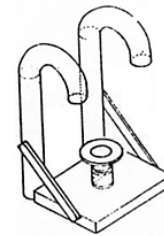

Deadheads - are used with short tubes to secure the beam to a tube. Used for guardrails or other non-load bearing members.

SHORES

Vertical shores (or as some of our customers call them – screw posts or teleposts) are used in shoring applications especially for re-shoring curing concrete or supporting beams while parts of walls or roofs are being worked on. Urban also carries trench shores used for bracing the walls of trenches. The trench shores have a lip and nail holes to attach them to the 2x4.



Urban carries the following sizes of shores

No 2	(5'8" – 10')
No 3	(7'4" – 11'8")
No 4	(8'4" – 13'8")
No 6	(10' – 18'4')



Trench Shores come in two sizes
60/20 (55" – 6.5')
50/150 (36" – 4'11")

Angel Wings

The angel wing is a lightweight man basket that hangs off steel structures. The Angel Wing is used on the construction of bridges, steel buildings, etc. Shown below are many areas where Angel Wings have been most useful.



The dimensions of the Angel wing Model IV are as follows .

- ..
- Base - 24 inches
- Width - 42 inches
- Height - 56 inches

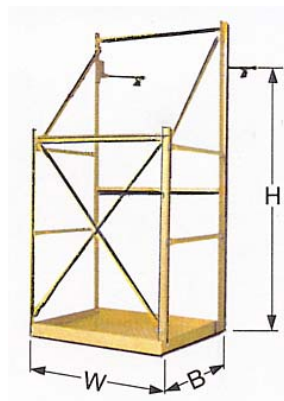

Supa Clamps

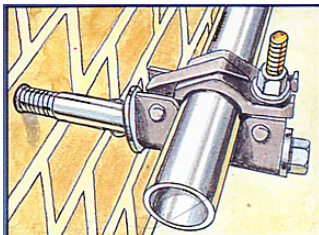

E Type Supa Tie

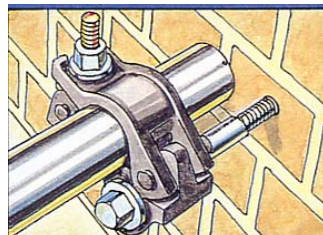

Supa Tie

Beam Clamps



Beam Clamps - are used to clamp to I-beams. They must be used in pairs. They work great for scaffold tie-ins.

Light Clamps



Light clamps can clamp onto any vertical or horizontal tube. They conveniently hold the light at any angle.

Tirfors

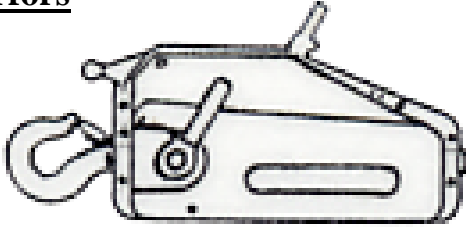

The Tirfor is a manual winch used in many applications. For demolitions, stump removal, heavy equipment lifting or pulling, formwork removal, dock hauling, etc.

Urban carries two types for sale.

T-7A – Lifting capacity of 750kg (1650 lbs)
– Pulling capacity of 1250kg (2750 lbs)
(5/16” wire rope is required not supplied)

and the

T-13A – Lifting capacity of 1500kg (3300lbs)
– Pulling capacity of 2500kg (5500lbs)
(7/16” wire rope is required not supplied)

“Kerisal” Propane Station



The “Kerisal” propane station is to be installed on the scaffold so the propane tank can sit outside the scaffold to keep in line with safety on job sites. The station is designed to be used on all types of scaffolds.

Hoarding can be attached to the scaffold and the “Kerisal” propane Station is attached to the outside of scaffolds that are hoarded in. This keeps the propane tanks safely outside of the structure. The propane tank would be easily accessed at the joints of the tarps.



This station is adapted for system scaffolds.

This station can be used on all 2” tubes.

“Kerisal” Boot Safety Station



The Boot Safety Station is designed with a scraper and metal scraping pad to clean off the workers boots before he accesses the ladder. The Boot safety station also has a bar for the workers to hold onto and a place to tie tags, permits and/or identification ribbons.

Removing the debris off the workers boots before climbing a ladder results is . . .

1. A reduction in slipping accidents. (No mud on the ladder rungs.)
2. A reduction in tripping hazards. (Tags are not attached to the ladder rungs.)
3. A saving on the number of gloves used. (Soiled from mud and debris)
4. A reduction in WCB claims. (Less accidents)



Boot Station is made of 1 3/8” material and can be made to fit any size of ladder or frame.

5. When used in front of a jobsite trailer, it can reduce the janitor cleaning.

Scaffold Training Courses

Competent Person Training and inspecting

Frame Scaffolds (Initial Course)

Classroom training + Practical training = Total 8 hrs

Tube & Clamp Endorsement

Classroom training + Practical training = Total 4 hrs

System Scaffold Endorsement

Classroom training + Practical training = Total 4 hrs

What the course includes . . .

Classroom Discussion

Rules & Regulations - New GSR	Access of scaffolds
Components and Material Storage	Discuss cantilevers and loads.
Foundations and sills	Guard rail systems
Hazard Awareness	Maintenance of components
Outriggery and Ties	Platform & Materials
Procedure for installing components	Inspection of Scaffolds
Typical uses of different types of scaffolds	Codes of Safe Work Practice

Practical Training for Frames

Build a rolling tower with stair access.

Build a 5x10' tower with inside ladder access.

Build a 5x10' tower with outside ladder access.

Dismantle each of the above scaffolds.

Demonstration of side & end brackets, universal base plates and narrow frames, Screwjacks U/H, Beam, & Dead heads, outriggers, putlogs and toeboards.

Scaffold Tags

All scaffolds should be inspected and tagged by a competent person.





Scaffold Safety Rules As recommended by **urban** **SCAFFOLDING LTD.**

Following are some common sense rules designed to promote safety in the use of steel scaffolding. These rules are illustrative and suggestive only, and are intended to deal only with some of the many practices and conditions encountered in the use of scaffolding. The rules do not purport to be all-inclusive or to supplant or replace other additional safety and precautionary measures to cover usual or unusual conditions. They are not intended to conflict with, or supersede, any provincial, local or federal statute or regulation; reference to such specific provisions must be made by the user or competent person. (See rule II)

- I. **POST THESE SCAFFOLDING SAFETY RULES** in a conspicuous place and be sure that all persons who erect, dismantle or use scaffolding are aware of them.
- II. **FOLLOW ALL OCCUPATIONAL HEALTH & SAFETY, LOCAL AND FEDERAL CODES, ORDINANCES, and REGULATIONS** pertaining to scaffolds.
- III. **INSPECT ALL EQUIPMENT BEFORE USING** – Never use any equipment that is damaged/deteriorated in any way.
- IV. **KEEP ALL EQUIPMENT IN GOOD REPAIR.** Avoid using rusted or corroded equipment – the strength of rusted or corroded equipment is not known.
- V. **INSPECT ERECTED SCAFFOLDS REGULARLY** to be sure that they are maintained in safe condition. Occupational Health requires the scaffold to be inspected every 21 days. Tag the scaffold.
- VI. **SCAFFOLDS MUST BE ERECTED IN ACCORDANCE WITH DESIGN AND/OR MANUFACTURERS’ RECOMMENDATIONS.** Scaffolds should be erected, dismantled and/or altered by a competent person or a person under the direct supervision of the competent person.
- VII. **DO NOT ABUSE OR MISUSE THE SCAFFOLD EQUIPMENT.**
- VIII. **NEVER TAKE CHANCES! IF IN DOUBT REGARDING THE SAFETY OR USE OF THE SCAFFOLD, CONSULT YOUR SUPPLIER.**
- IX. **DO NOT WORK ON SCAFFOLDS** if your physical condition is such that you feel dizzy or unsteady in any way.
- A. **PROVIDE ADEQUATE SILLS** for scaffold posts and/or use base plates.
- B. **USE ADJUSTING SCREWS** instead of blocking to adjust uneven grade conditions.
- C. **PLUMB and LEVEL ALL SCAFFOLDS** as the erection proceeds. Do not force braces to fit – level the scaffold until proper fit is made easily.
- D. **SECURELY FASTEN ALL SCAFFOLD COMPONENTS.**
- E. **DO NOT CLIMB CROSS BRACES.** An access (climbing) ladder, access steps, frame designed to be climbed or equivalent safe access to the scaffold shall be used.
- F. **SCAFFOLD TIES MUST RESTRAIN COMPRESSION AND TENSION.** The anchor for the ties must be secured and maintained every 6.4m (20’) horizontally and every 4.6m (15’) in vertical height.
- G. **WHEN SCAFFOLDS ARE TO BE PARTIAL OR FULLY ENCLOSED,** specific precautions must be taken to ensure frequency and adequacy of ties attaching the scaffold to the building due to increased load conditions resulting from effects of wind and weather. Occupational Health and Safety states that ties on enclosed scaffolds must be 3m (10’) horizontally and 3m (10’) vertically.
- H. **FREE STANDING SCAFFOLD TOWERS MUST BE RESTRAINED FROM TIPPING** by guying or other means. The scaffold height to base ratio must not exceed three (3) times the narrowest base.
- I. **ALL PLATFORMS OR STAGES** above 3m must be equipped with proper guardrails, midrails and toeboards along all open sides and ends.
- J. **POWER LINES NEAR SCAFFOLDS** are dangerous – use caution and consult the power service company for advise. If in doubt stay at least 7 meters from the line.
- K. **DO NOT USE** ladders or makeshift devices on top of the scaffolds to increase the height.
- L. **DO NOT OVERLOAD SCAFFOLDS.**
- M. **PLANKING**
 1. Use only lumber that is properly inspected and graded as a scaffold plank.
 2. Planking shall have at least 300mm (12”) of overlap and extended a minimum 150mm (6”) beyond the center of support, or be cleated at both ends to prevent slipping off supports.
 3. Fabricated scaffold planks and platforms unless cleated or restrained by cleated or restrained by hooks shall extend over their end supports not less than 150mm (6”) nor more than 300mm (12”).
 4. Secure planks and platforms to the scaffold.
- N. **FOR ROLLING SCAFFOLD THE FOLLOWING ADDITIONAL RULES APPLY:**
 1. **DO NOT RIDE ROLLING SCAFFOLDS.**
 2. **SECURE OR REMOVE ALL MATERIAL AND EQUIPMENT** from platform before moving scaffolds.
 3. **CASTOR BRAKES** or blocked wheel shall prevent swivel and rotating movement when workers are on the scaffold.
 4. **CASTORS** shall be attached to the frame or screwjack by pins or other suitable means.
 5. **DO NOT ATTEMPT TO MOVE A ROLLING SCAFFOLD WITHOUT SUFFICIENT HELP** – watch out for holes in the floor and overhead obstructions.
 6. **DO NOT EXTEND ADJUSTING SCREWS ON ROLLING SCAFFOLDS** more than 300mm (12”).
 7. **USE HORIZONTAL DIAGONAL BRACING** near the bottom and at 6.4m (20’) intervals.
 8. **DO NOT USE BRACKETS ON ROLLING SCAFFOLDS** without consideration of overturning forces.
 9. **THE WORKING PLATFORM HEIGHT** must not exceed three (3) times the smallest base dimension unless it is guyed or otherwise stabilized.
- O. **For PUTLOGS and TRUSSES the following additional rules apply**
 1. **DO NOT CANTILEVER OR EXTEND PUTLOG/TRUSSES** as side brackets without thorough consideration for loads and horizontal forces.
 2. **PUTLOG/TRUSSES SHOULD EXTEND** at least 150mm (6”) beyond the point of support unless knee braced.
 3. **PLACE PROPER BRACING BETWEEN PUTLOGS/TRUSSES** when span of Putlogs/Trusses is more than 12’.
- P. **ALL BRACKETS** shall be seated correctly with side brackets parallel to the frames and end brackets at 90 degrees to the frame. Brackets shall not be bent or twisted from normal position. Brackets are to be used as work platforms only and NOT used for storage of material or equipment.
- Q. **ALL SCAFFOLD ACCESSORIES** shall be used and installed in accordance with the manufacturer’s recommended procedures. Accessories shall not be altered in the field. Scaffolds, frames and their components, manufactured by different companies shall not be intermixed.